

**1/18 Scale Gas Powered  
4WD Racing Buggy Body  
(For MBX-6)**

NO.48055

**killerbody™**

1/8RC PLANNING INSTRUCTION SHEET

**Before beginning assembly, please read these instructions thoroughly!**

● Symbols used throughout the instruction manual, comprise:



Cut off shaded portion.



5mm  
Drill holes with  
the specified diameter.



Pay close attention here!



Must be purchased  
separately.



Assemble left and right sides  
the same way.

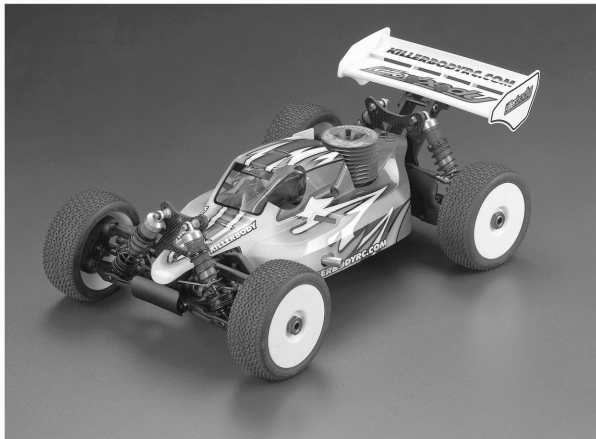

● Before Assembly

Decoration Body

- ▶ In the case of a decoration body, please assemble it according to the contents showed.

When making the window transparent:

- ▶ If you want to make the window transparent with a non decoration body, please assemble it according to the contents showed.

Non Decoration Body

- ▶ In the case of non decoration body, please assemble it according to the contents showed.

# 1 Body Shell

Non Decoration Body

When making the window transparent:

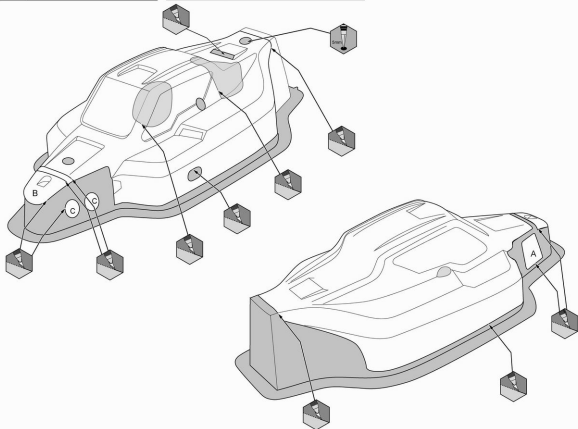

# 2 Painting

Non Decoration Body

- 1 Before painting, use a neutral detergent to remove any oil residues and dirt.

When making the window transparent:



When making the window transparent:

- 2 Mask the windows from the inside.

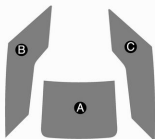

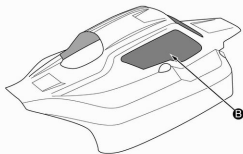
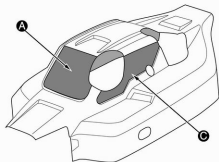

3 Paint the body shell from the inside.



4 After painting, remove the protective film from the body shell.

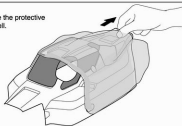

### 3 Decal

Non Decoration Body

When making the window transparent

▶ The decal numbers between brackets are only for the opposite side.



< Decal >

When making the window transparent



▶ 1 2 3 Cut the translucent (smoked color) part.

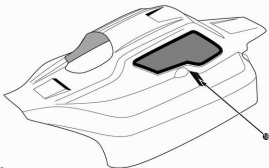
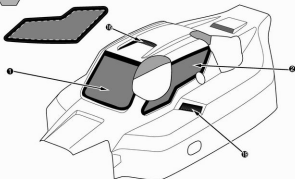

## 5 Body

Decoration Body

Non Decoration Body

When making the window transparent:

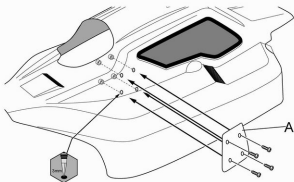

## 6 Body

Decoration Body

Non Decoration Body

When making the window transparent:



For safety reasons, always fit the body shell when running your car.

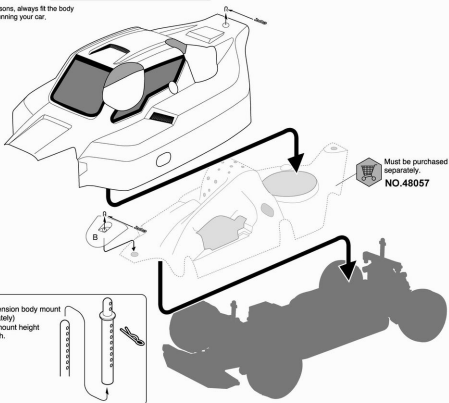

Use the extension body mount (sold separately) if the body mount height is not enough.

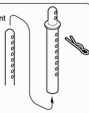

## Option Parts & Accessory

No.	Part Names	No.	Part Names
48055	1/8 Scale Gas Powered 4WD Racing Buggy Body (For MBX-6) Clear Body		
48056	1/8 Scale Gas Powered 4WD Racing Buggy Body (For MBX-6) Printed Body		
48057	Chassis Protector 1/8 Scale Gas Powered 4WD Racing Buggy Body (For MBX-6)		